Tenstorrent Galaxy™ Wormhole™ Server

User Guide
Version 1.5

Last Updated Date: June 30, 2026

© 2026 Tenstorrent Holdings Inc. and its subsidiaries.

The information contained herein is for informational purposes only and is subject to change without notice. While every precaution has been taken in the preparation of this document, it may contain technical inaccuracies, omissions and typographical errors, and Tenstorrent is under no obligation to update or otherwise correct this information. Tenstorrent, Inc. makes no representations or warranties with respect to the accuracy or completeness of the contents of this document, and assumes no liability of any kind, including the implied warranties of noninfringement, merchantability or fitness for particular purposes, with respect to the operation or use of Tenstorrent products described herein. No license, including implied or arising by estoppel, to any intellectual property rights is granted by this document. Terms and limitations applicable to the purchase or use of Tenstorrent products are as set forth in a signed agreement between the parties or in the Tenstorrent Standard Terms and Conditions of Sale.

The technical data presented in this document may be subject to U.S. and international export, re-export, or transfer ("export") laws. Diversion contrary to U.S. and international law is strictly prohibited. The user and recipient of this document must comply with all the applicable regulations and laws which include restrictions on prohibited destinations or countries, end users, and product usage. If in doubt, contact the appropriate US Export Control Agency or Tenstorrent, Inc.

TRADEMARKS

A list of Tenstorrent's trademarks can be found at <https://tenstorrent.com/trademarks>. Other product names and links to external sites used in this publication are for identification purposes only and may be trademarks of their respective companies.

*Links to third party sites are provided for convenience and unless explicitly stated, Tenstorrent is not responsible for the contents of such linked sites and no endorsement is implied.

Table of Contents

Table of Contents	2
Revision History	3
Introduction	4
Important Safety Information	5
1. Hardware Setup and Site Requirements	6
1.1 Packaging and Weight	6
1.2 Installation Equipment and Requirements	7
1.2.1 Rack Specifications	7
1.3 Power Requirements and Recommendations	7
1.4 Temperature and Humidity	7
1.5 Connectivity	8
1.5.1 Ethernet Connectivity	8
1.6 Networking	8
2. Specifications	10
2.1 Server Features and Specifications	10
2.2 Board Management Controller (BMC) Operation	11
2.2.1 First Time BMC Login	11
2.2.2 BMC Specifications	11
2.2.3 BMC Controls	13
2.2.4 BMC Remote Console	15
2.3 System Information	15
3. System Overview	16
3.1 System ISO View	16
3.2 System Front View	17
3.3 Storage Drive Overview	18
3.4 Front Control Panel	19
3.5 System Rear View	20
3.5.1 Rear I/O Ports	21
3.6 Power Block Diagram	22
4. Hardware Installation	23
4.1 Assembling the Rail Kit to Rack	23
4.2 Securing the Server to Rack	24
5. Software and Firmware	26
5.1 Software	26
5.2 Firmware	26
5.3 Driver, Firmware, and Software Installation	27
Install System Management Interface (TT-SMI)	29
Install Metalium	30
5.4 Troubleshooting	31
6. Server Reset	32
7. Server Shutdown	33
8. Compliance	37

Revision History

Revision	Release Date	Notes
0	May 30, 2025	Beta Release
0.1	Jun 9, 2025	Beta Release with Chris Gill comments incorporated
0.2	Aug 21, 2025	New images + power specs + EMC caution language
0.3	Sep 3, 2025	Updated voltage, added EMC, Safety, and Caution notices
0.4	Sep 3, 2025	Updated Canada safety logo, caution notices, Taiwan EMI statement and host processor GHz
0.5	Sep 9, 2025	Updated EMC and Safety sections to include countries that have no specific legal requirements.
0.6	Sep 16, 2025	Updated installation language, Ethernet cable specs and general cable cautions. Removed Taiwan and Japan from Regulations section
0.7	Sep 16, 2025	Updated images on page 8
0.8	Sep 26, 2025	Added generic Class A warning; added proper disposal warning. Added heat and airflow specs. Modified power supply language. Added new export notice. Updated Server rest instructions. Condensed ToC.
0.9	Nov 03, 2025	Updated Power section with caution to avoid using three PSUs. Updated hot swappable parts to include PSUs, fans and E1.S drives. Added Brazil radio safety warning. Revised "Warning" and "Danger" labels. Removed Compliance section with note to check docs.tenstorrent.com for most up to date info.
1.0	Nov 18, 2025	Added additional safety language based on UL Test Report and Procedure issued June 2, 2025
1.1	Jan 14, 2026	Added lithium battery warning. BMC section updated. Firmware section updated.
1.2	Jan 16, 2026	Added new Firmware section from "Installing and Troubleshooting Galaxy Wormhole 6U Systems"
1.3	Jan 20, 2026	Updated typo in ToC
1.4	Jan 22, 2026	Updated BMC password, added hearing safety warning
1.5	June 30, 2026	Added Japan VCCI statement. Updated power source caution and hot surfaces warning, formatted caution boxes with yellow color. Minor updates to safety warning language. Revised lowest operating temp to 10C.

Introduction

The Tenstorrent Galaxy™ Wormhole™ Server is a high performance, 6U rack mounted server designed to handle the most demanding AI and HPC workloads. It is specially optimized to expedite AI training and inferencing, including natural language processing and supercomputing applications, delivering 2.4 TOPS per Watt efficiency with peak performance of 408 TOPS across all 32 Tensix processors during FP8 operations.

Tenstorrent Galaxy Wormhole Servers are designed to easily cluster and scale, with comparatively low power consumption and cooling requirements that reduce operational and maintenance costs. The Tenstorrent Galaxy features remote access and monitoring capabilities, enabling customers to access and control server data from anywhere at any time.

This User Guide describes the components and specifications of a single Server, as well as installation instructions and compliance information.



Important Regulatory and Safety Compliance Information

EMC - Class A Warning

Notice: This is a Class A product designed for use in a commercial environment. In a domestic environment, this product may cause radio interference, in which case the user may be required to take adequate measures.

This device complies with Part 15 of the FCC Rules. Operation is subject to the following two conditions: (1) This device may not cause harmful interference, and (2) this device must accept any interference received, including interference that may cause undesired operation.

This equipment has been tested and found to comply with the limits for a Class A digital device, pursuant to Part 15 of the FCC Rules. These limits are designed to provide reasonable protection against harmful interference when the equipment is operated in a commercial environment. This equipment generates, uses, and can radiate radio frequency energy, and if it is not installed and used in accordance with the instruction manual, it may cause harmful interference to radio communications. Operation of this equipment in a residential area is likely to cause harmful interference, in which case the user will be required to correct the interference at his own expense.

This Class A digital apparatus complies with Canadian ICES-003.

WARNING - Modifications to this Server are not expressly approved by Tenstorrent may void the user's authority to operate this Server. Tenstorrent cannot accept responsibility for failure to satisfy any safety, EMC or regulatory requirements that result from a non-approved modification of the Server – this includes the fitting of non-Tenstorrent recommended cards, power cables, Ethernet cables, or any other hardware or software modification that may affect compliance.

To avoid both damage to the Server and personal injury, only use Tenstorrent approved hardware in conjunction with this Server.

Do not use this Server in a way that it was not designed to be used.

For detailed information on servicing and troubleshooting, please review the Tenstorrent Galaxy Wormhole Field Service Manual. Server maintenance and replacement of internal parts should only be performed by a skilled professional, due to the heat and hazardous moving parts presents inside the unit.

1. Hardware Setup and Site Requirements

1.1 Packaging and Weight

**Warning: Heavy Object**

Due to the heavy weight of the Server (262 lbs/ 119 kg), use of a Server Lift is required. We strongly recommend installation is done with at least two people. This is to protect against personal injury and Server damage.

The server weighs 119kg (262 lbs) and chassis dimensions are 447mm x 266.7mm x 884mm.

The Tenstorrent Galaxy Wormhole™ Server package contains:

- 1x Tenstorrent Galaxy Wormhole™ Server
 - 4x power supply cords (3m IEC320-C20 3P 250V UL)
- 1x Static Rail kit
 - 4x M5x10 screws
- Tenstorrent Ethernet cables
 - TX-02001 rev 1 or rev 2
- Power cables specified by user at time of purchase

The Server contains multiple self-contained Class I (1) Laser optical transceiver modules. Use only a certified optical fiber transceiver Class I (1) Laser product for replacement.

**Warning: Cables.**

Only use cables in conjunction with this Server that are recommended by Tenstorrent. Any replacement cables must be of the same type and wire gage as the original cables shipped with the Server. Using alternative cables not approved by Tenstorrent may result in device damage, dangerous operating conditions, or non-compliant operation.

**Caution: Risk of hearing damage.**

Exposure to high volume sound levels for long periods can damage hearing. Use hearing protection when installing, servicing, or working near this server.

1.2 Installation Equipment and Requirements

The Server must be installed/integrated and serviced only by technically qualified professionals. The Server is intended for installation in a Restricted Access Area. Professional installation ensures the Server operates safely and effectively while preventing property damage and personal injuries. The professional installer assumes all responsibility for compliance with local regulatory and safety requirements during installation.

Ensure you have the following equipment on hand before beginning installation:

- A standard pallet jack, skid steer, or pump truck
- Server Lift
- Phillips head screwdriver
- A permanently attached Green-Yellow, 14AWG or 2.5mm² ground cable fixed with a washer

Due to the heavy weight of the Server (262 lbs), use of a Server Lift is required. We strongly recommend installation is done with at least two people. This is to protect against injury and Server damage.

1.2.1 Rack Specifications

The Tenstorrent Galaxy Server is intended to be installed on an EIA-compliant 19" (482.6mm) rack. Any other racking solution requirements should be discussed with Tenstorrent ahead of time.

1.3 Power Requirements and Recommendations

The Server's internal AC/DC power supply is comprised of four 4000-watt 80 Plus Titanium hot-plug Power Supply Units (PSUs), each with a 54Vdc regulated main output (V1) over 70A and 12Vdc auxiliary standby output (Vsb) at 3A. The power supply cords must be plugged into sockets/outlets which provide a suitable earth ground. Each of the four provided power cords are three meters in length.

The four PSUs work in a 3+1 redundant configuration, and the expected peak power consumption of the Server is 12kW.

1.4 Temperature and Humidity

Ideal server operation conditions:

- Operating temperature: 10C to 35C (41°F to 95°F) dry-bulb
- Operating relative humidity: 20% to 85%
- Storage temperature: -40°C to 70°C (-40°F to 158°F) dry-bulb
- Storage relative humidity: 10% to 95%
- Heat output: 34,633 BTU/hr @ 35°C amb under a typical strenuous workload
- Airflow requirement: 1229 CFM @ 80% fan PWM under a typical strenuous workload

1.5 Connectivity

The Server can be operated in either a grid (no cables) or torus topology.

Torusing provides the benefit of decreased latency (by decreasing the hop count between chips) and is recommended for high performance operations. However, it is not required to operate the Server in a torus.

Both grid and torus topologies can be expanded to multiple systems using different cabling techniques. Please reach out to your Tenstorrent rep to discuss the best topology for your specific workload(s).

1.5.1 Ethernet Connectivity

The following diagram is of the Ethernet cable routing present in a single Tenstorrent Galaxy Wormhole Server, in its default 2D torus topology. Each Server comes with cables set in a recommended configuration but users may customize the cabling as needed. Supported maximum cable length is 2.5 meters for DAC and 30 meters for AOC.

For installations of multiple Tenstorrent Galaxy Wormhole Servers, multi-system cabling diagrams and examples can be provided. Please contact your Tenstorrent representative to plan such deployment ahead of ordering.

1.6 Networking

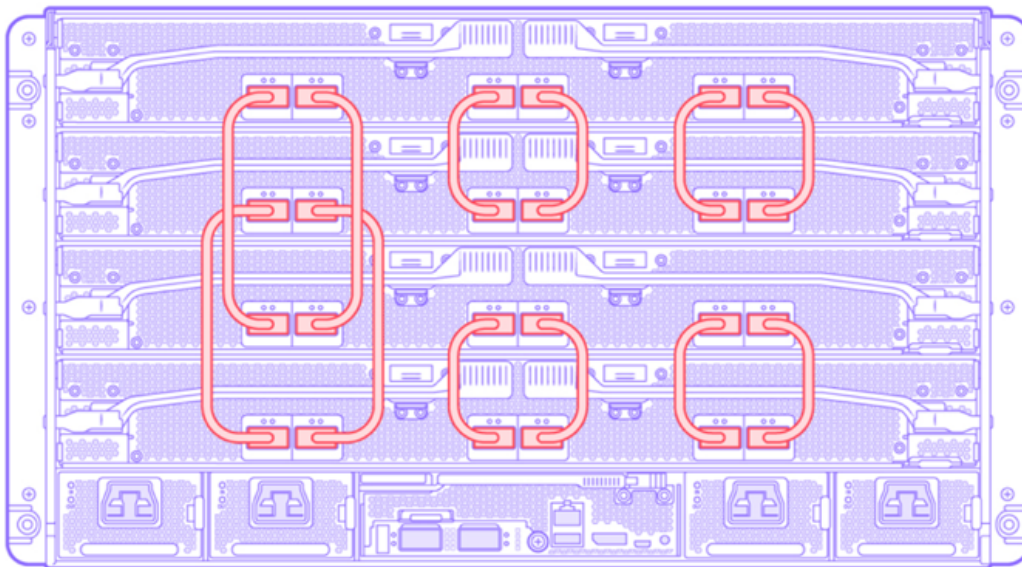

Figure 1

Diagram of Default Single Server Cable Routing

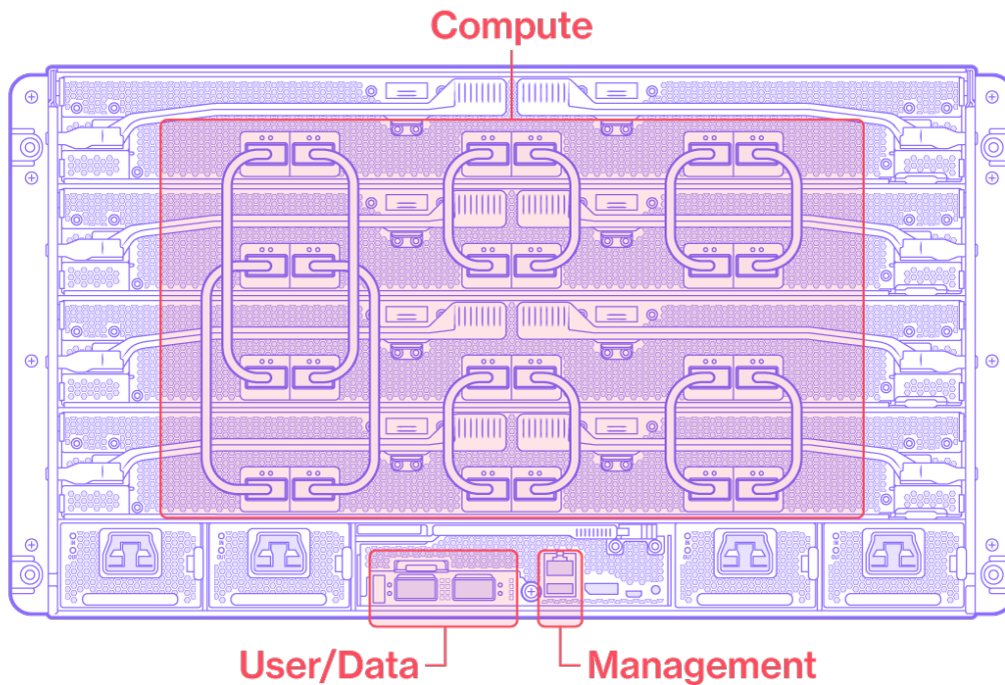

Figure 2
Highlight of Networking Areas

	Management	User/Data	Compute
Description	Used to monitor and troubleshoot servers by IT infrastructure teams.	Links the cluster to the enterprise so users/data can get into the cluster.	Carries traffic across the TT-Fabric of chips for processing of data.
Speed	1 GbE	100 GbE Broadcom N2100G	400 Gbps
Links Per Galaxy	1x	2x	24x
Port Type	RJ-45	QSFP56	QSFP-DD
Switching	Standard Ethernet	High Speed Ethernet	None, handled by TT-Fabric

2. Specifications

2.1 Server Features and Specifications

Specification	Description
Model Number	TG-00002
Form Factor	6U Rackmount (air-cooling)
Chassis Dimensions (W x H x D)	447mm x 266.7mm x 884.5mm (17.60" x 10.5" x 34.8")
Mainboard Form Factor (W x L)	147mm x 485mm
Tray Form Factor (W x L)	431mm x 600mm 4 Trays
AI Accelerator	32x Wormhole Tensix™ Processors (8 processors per tray across 4 trays) @ 170W each
Host Processor	AMD EPYC 9354P, 32 cores, 3.25 up to 3.8GHz, Socket SP5/LGA 6096, 280W TDP
Host Memory	576 GB (6x 96 GB) DDR5-4800 ECC RDIMM (6 slots, 0 free)
Internal PCIe Connectivity	4x trays with PCIe 4.0 (one x8 lanes, seven x1 lane)
Internal Connectivity	6x 400 Gbps QSFP-DD and 8x 56G PAM4 per tray
Networking	1x Dedicated 1GbE BMC management LAN port 1x OCP 3.0 NIC 2x 100/50/40/25/10 GbE QSFP-56 ports via Broadcom N2100G
Expandable Storage	4x hot-plug E1.S PCIe 4.0 9.5/15mm NVMe SSD drive bays
Storage	2x M.2 2280 NVMe PCIe 3.0/4.0 x4 Drive Slots (Populated with 2x 960 GB M.2 2280 NVMe drives) 4x Hot-Plug E1.S 9.5mm/15mm PCIe 4.0 x4 SSD Drive Bays (Populated with 4x 4 TB or 4x 8 TB E1.S drives)
BMC Storage	1x SD card slot with included 32 GB SD card
Front I/O	1x Power button/LED 1x Reset button 1x ID button/LED 1x System Status LED 1x Tray Status LED 2x USB 3.0 Type-A ports 1x Bezel connector
Rear I/O	1x DisplayPort 1.1a 1x USB 3.0 Type-A port (from CPU) 1x COM port (USB Type-C, for debug use only; this is not a generic USB-C port, please see Rear I/O section for more details) 1x Dedicated 1 GbE BMC LAN port
Video	ASPEED AST2600 with integrated 1 GB DDR4 video memory Maximum display resolution up to 1920x1200p 32bpp@60Hz

Specification	Description
Fan	8x hot-swap 9276 dual rotor fans (N+1 redundant) - 54V 2x hot-swap 6056 dual rotor fans (N+1 redundant) - 12V
TPM	TPM 2.0 SPI module
ACPI	ACPI compliance, S0, S5 support
Power Supply	3+1 4000W 80 Plus Titanium redundant hot-plug PSUs. Peak consumption: 12kW operational, 16kW total PSU capacity.
System Rating	220-240Vac, 50/60Hz, 16A (x4) or 240Vdc, 16A (x4)
BMC	ASPEED AST2600 with 1x Dedicated 1GbE BMC management LAN port

Battery note: The motherboard contains a non-rechargeable **CR2032 lithium coin cell battery**, which runs the motherboard's RTC and backs the CMOS/NVRAM.



Caution: Lithium Ion Battery. The motherboard contains a non-rechargeable CR2032 lithium coin cell battery. There is a risk of fire or explosion if the battery is replaced by an incorrect type. In the event of needing a replacement, only use a non-rechargeable CR2032 battery, and observe polarity when installing.

2.2 Board Management Controller (BMC) Operation

The Board Management Controller (BMC) utilizes a single ASPEED AST2600 module with a dedicated 1GbE BMC LAN Port on the rear I/O. The BMC utilizes OpenBMC software.

2.2.1 First Time BMC Login

Please use the standard set of credentials set on the BMC:

username = root

password = 0penBmc

Connect the system via LAN and navigate to the system's IP address (<https://<bmc-ip-address>/>) to login. Resetting the system can be done within `ipmitool` in the host OS.

2.2.2 BMC Specifications

The BMC reports the Server IP address. To monitor Wormhole Tensix Processor specifications like frequency, power, and firmware version, run `tt-smi` in the host OS.

The BMC console is in OpenBMC, located under Operations > KVM. Please see the screenshots in Figures 3 and 4.

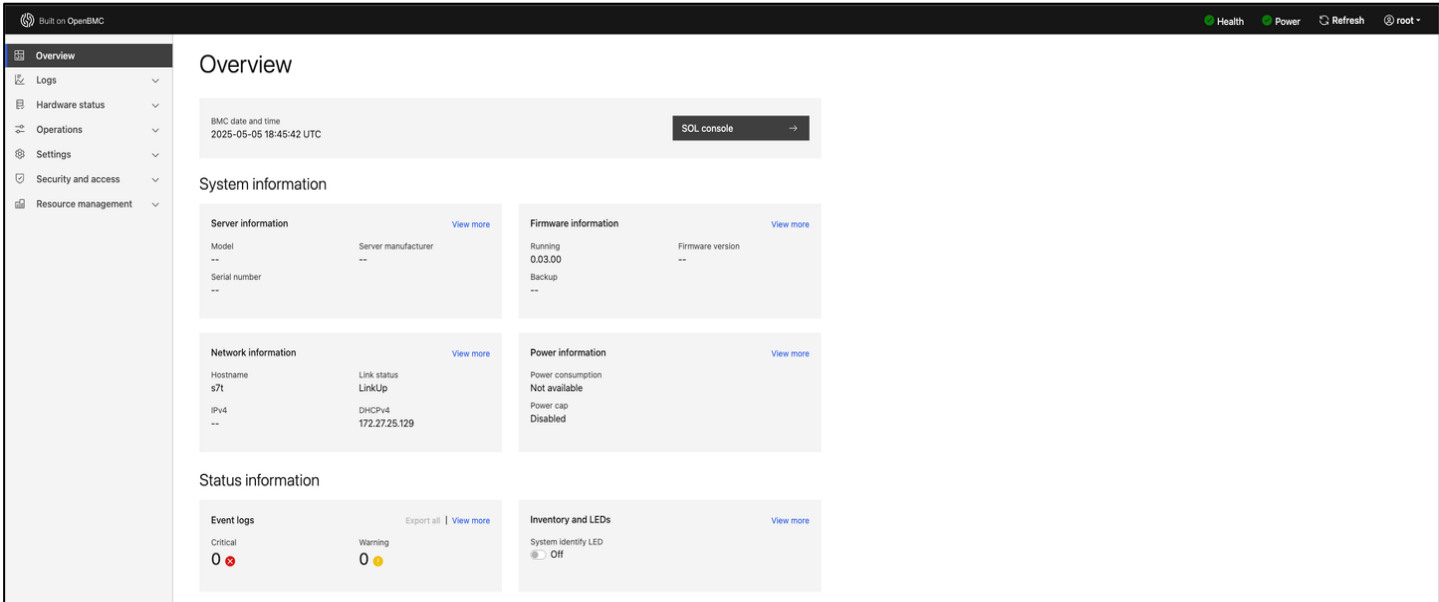

Figure 3
Screenshot of BMC Overview Page



Figure 4
Screenshot of BMC Console Page

2.2.3 BMC Controls

The left-side menu bar provides the primary BMC controls.

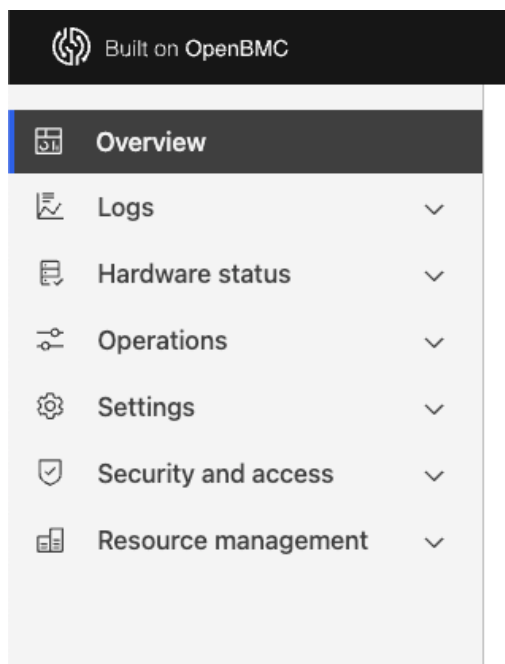

BMC Main Controls

Control	Description
Overview	Main login page, displaying top-level system status
Logs	Event Logs and POST code logs
Hardware Status	System HW status, LED control and System sensor information
Operations	Provides access to the following: Factory Reset, KVM, Key clear, Firmware, Reboot BMC, SOL Console, Server power operation, Virtual media
Settings	Provides access to following system settings: Date and Time, BMC network settings, Power restore policy
Security and access	Provides access to following Security and access settings: Sessions, LDAP, User Management, Policies, Certificates
Resource Management	Power cap settings

The top-right menu bar provides access to system health, power control and profile settings.

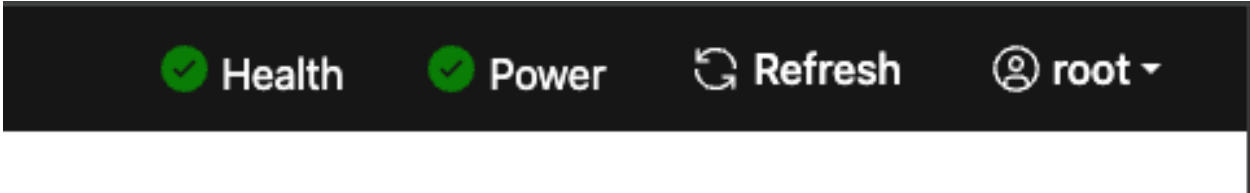

BMC Secondary Controls

Control	Description
Health	System Event logs
Power	Server power operations (Boot settings, Reboot, Shutdown)
Refresh	Refresh BMC status
Profile	Profile Settings (BMC password, Timezone) Logout of BMC

2.2.4 BMC Remote Console

Select Operations -> KVM from left side menu bar and login to the KVM terminal.

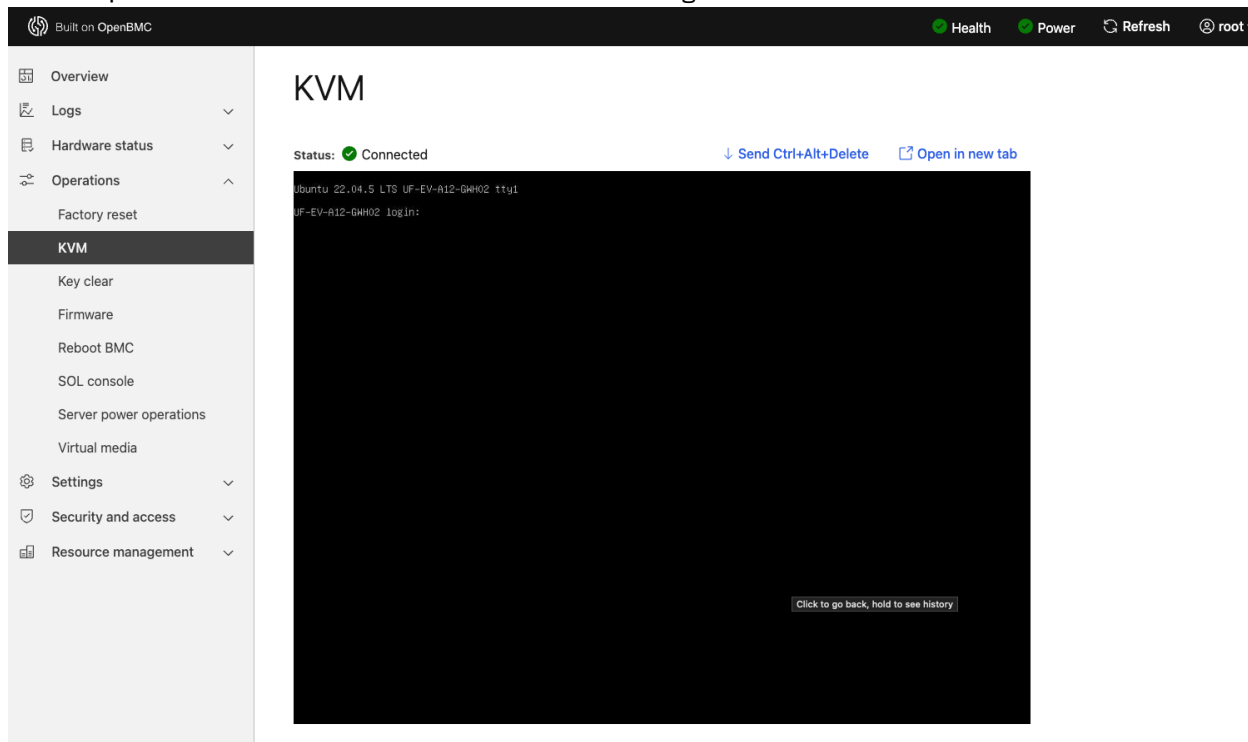

2.3 System Information

To perform a system information read, see the TT-SMI README.md at

<https://github.com/tenstorrent/tt-smi/blob/main/README.md>

In the Tenstorrent TT-SMI GitHub repository, there are instructions for building from git, as well as usage, resets, disabling software versions, taking system snapshots, and more.

Once installed, to bring up the tt-smi GUI run `$ tt-smi`

This should bring up a display where a user can view device information, telemetry and firmware.

Running `$ tt-smi -help` brings up an updated menu of commands to view hardware information, resetting ASICs and specific trays, reading active chips, initiating resets, and more.

3. System Overview

3.1 System ISO View

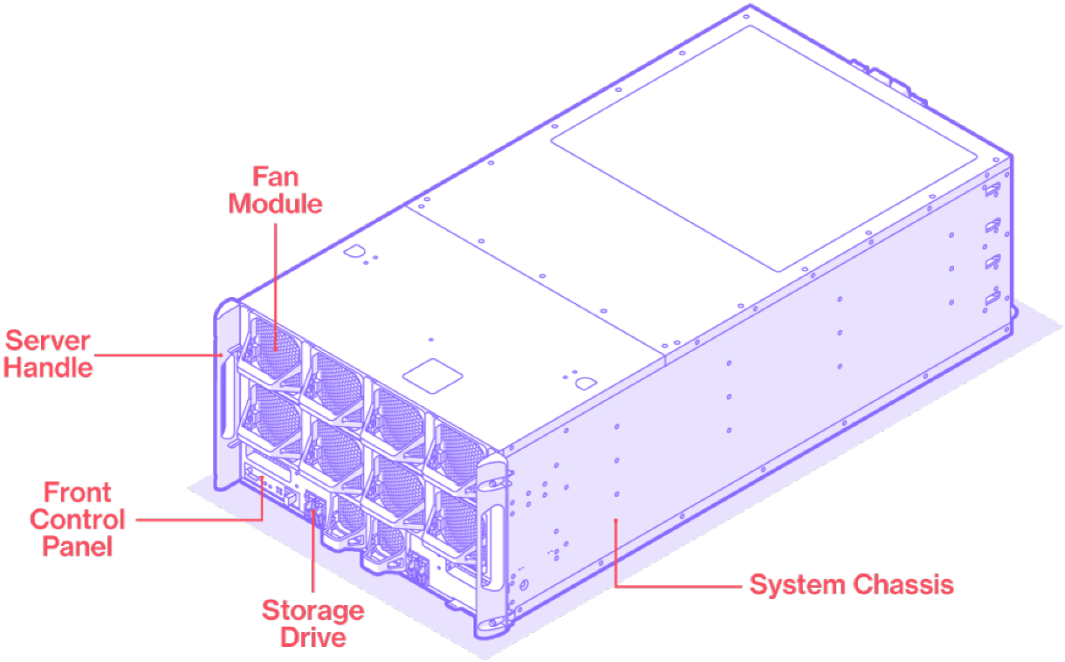

Figure 5
System Overview (with Bezel Removed)

No.	Item	Description
1	Storage drive	4x E1.S Storage
2	Fan	8+2 Fans for Trays and MB
3	Server handle	Two server handles used to pull the system out of the rack.
4	Front control panel	See the following page for more information.

3.2 System Front View

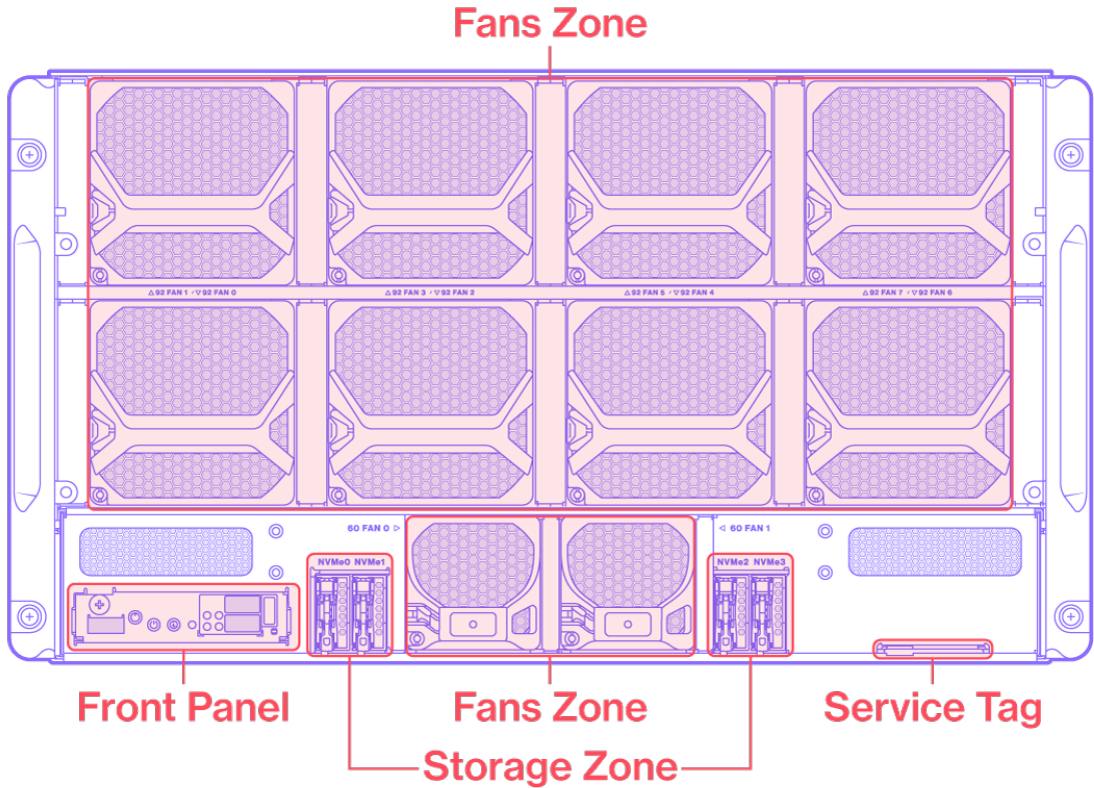

Figure 6
System Front View

Zone	Item	Description
Fan Zone	54V Fan	8x 9276 Fan for Tray TTP
Fan Zone	12V Fan	2x 6056 Fans MB CPU
Storage Zone	E1.S	4x E1.S NVMe storage device
Front control panel	Front control panel	See the following page for more information.
Service Tag	Service Tag	Location of serial number or other identifying information.

3.3 Storage Drive Overview

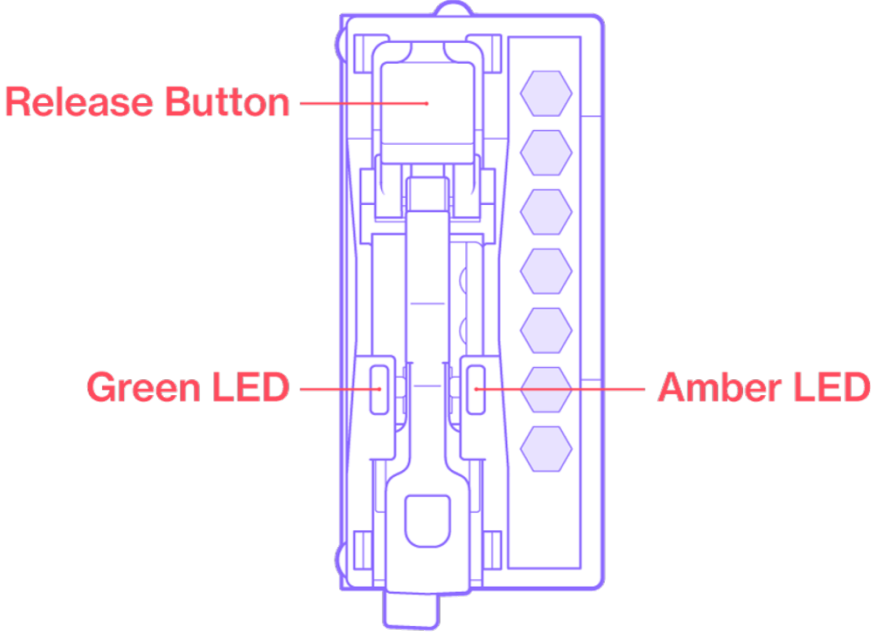

Figure 7
E1.S Overview

LED Color	State	Meaning
Green	Solid	Power is on; no issues.
Green	Blinking (4 Hz)	Host-initiated I/O activity is occurring.
Green	Off	Device is not receiving power.
Amber	Solid	Fail indicator; troubleshooting is needed.
Amber	Blinking (1 Hz)	Rebuild is needed.
Amber	Blinking (4 Hz)	Locator light for remote troubleshooting in data centers. A user can go through the BMC to tell the server to identify itself. The amber LED will then blink at 4hz.
Amber	Off	System is at normal.

3.4 Front Control Panel

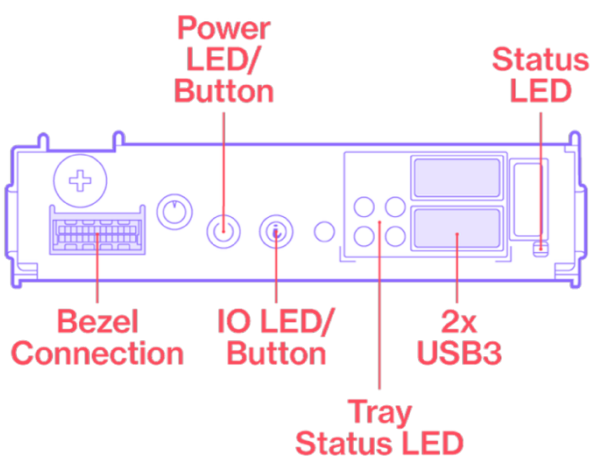

Figure 8
Front Control Panel

Name	Color	Behavior	Description
Power LED	Blue	On	System power is on.
		Off	System power is off.
		1Hz Blinking	Powering on - Phy-Initialization phase.
		4Hz Blinking	AC power on BMC boot phase - indicates that the BMC is not available.
ID LED	Blue	Off	Normal.
		Blinking	Unit is identifying itself as requested.
Status LED	Amber	Off	Normal.
		Blinking	Critical Event. Check cause in SEL log. Clear SEL log to return to normal.
Tray Status LED	Green/Amber	Off	Tray not installed.
	Green	On	Normal, Tray Installed.
	Amber	Blinking	Some Tensix Processors on the tray are not available.
Bezel Connector	n/a	n/a	Used to connect to the Bezel board, which is used for controlling the behavior of the Bezel LED.
Reset Button	n/a	n/a	System Reset.
2x USB 3.0 Type-A	n/a	n/a	USB 3.0 (5 Gbps) Type-A ports.

3.5 System Rear View

The system rear consists of one mainboard sled, four UBB tray sleds, and four power sockets.

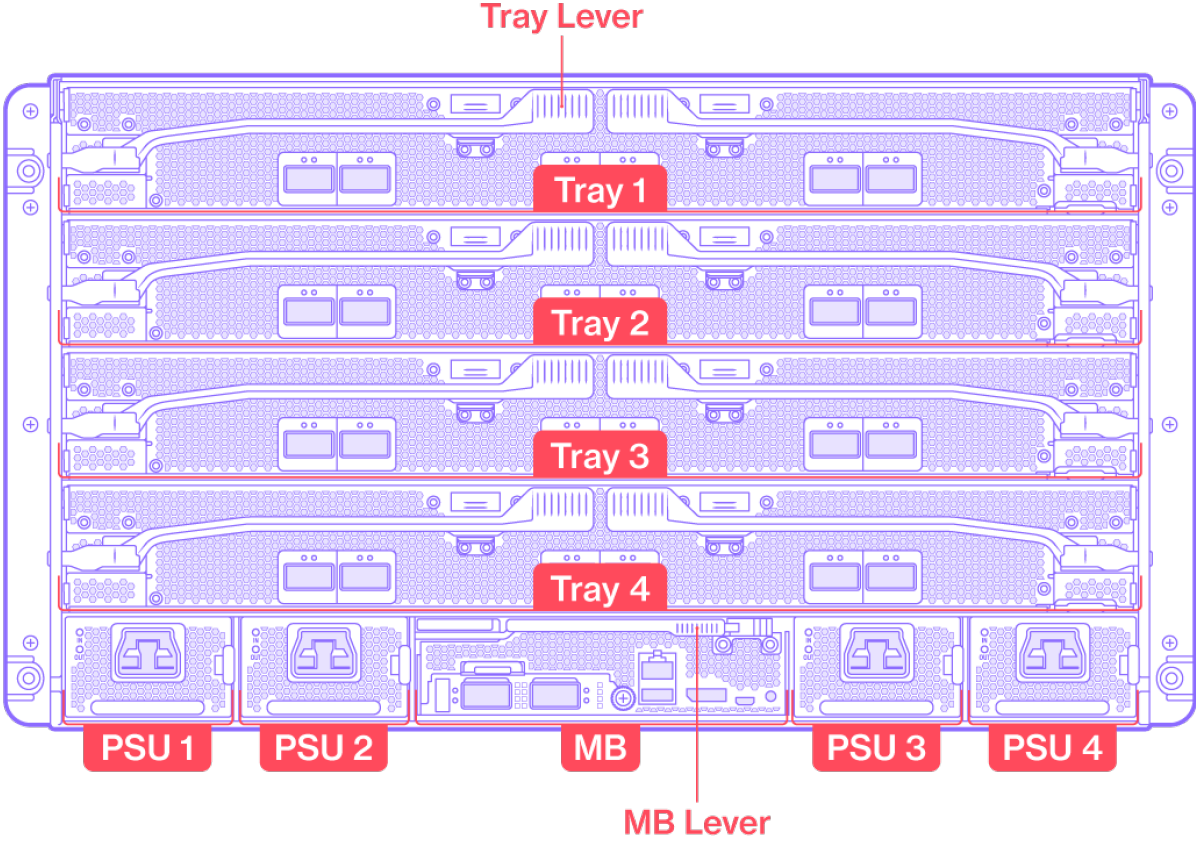

Figure 9
System Rear View

3.5.1 Rear I/O Ports

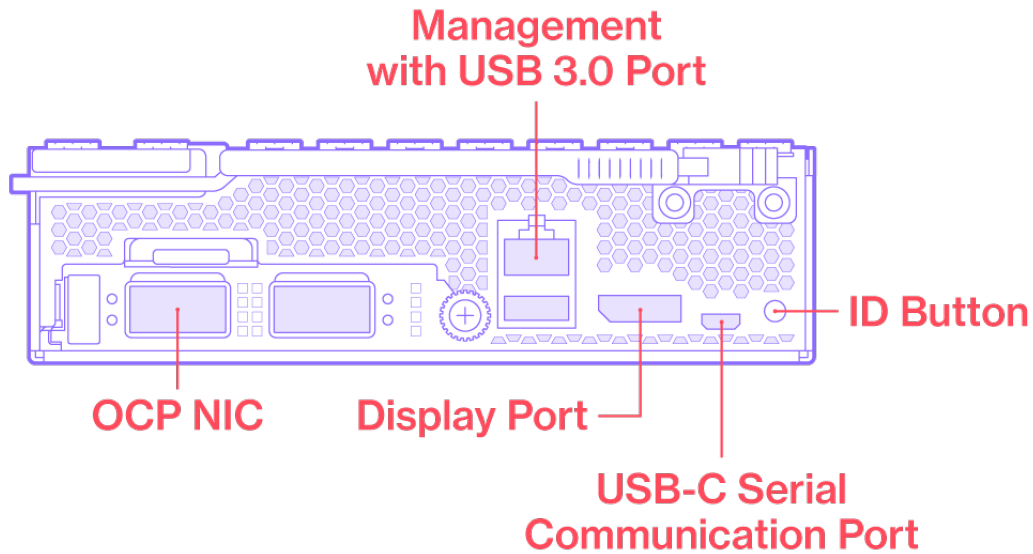

Figure 10
Rear I/O View

No.	Item	Description
1	OCP NIC	OCP 3.0 SFF PCIe 5.0 x16 slot.
2	Management with USB 3.0 port	Dedicated 1 GbE BMC LAN port (RJ45) for remote control/management. Connect to USB device (from CPU).
3	DisplayPort	Standard DisplayPort compatible, supporting up to 1920 x 1200 32bpp@60Hz resolution.
4	USB-C port	<u>To be used for serial communication between server, UART console and BMC only.</u> This port will show up as four independent serial ports on the system. It connects to both BMC (AST2600) & BIOS (AMD CPU) UART console. Please ensure console redirection is enabled in BIOS settings.
5	ID Button	Identification light

3.6 Power Block Diagram

The power delivery diagram below shows the power distribution from the PSU to the fan, MB, and TTP.

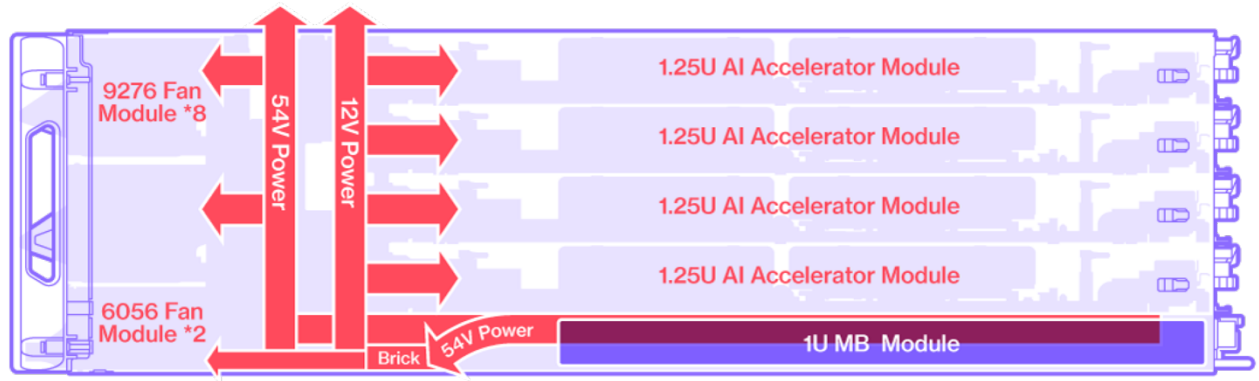

Figure 11
Power Block Diagram

4. Hardware Installation

4.1 Assembling the Rail Kit to Rack

The rail kit is designed to securely attach the Server to a standard width, 19" server rack.

The rail is retractable. Extend the rail to the rack post and snap the rail into place. Then, secure with the 4x M5 screws using a Phillips head screwdriver.

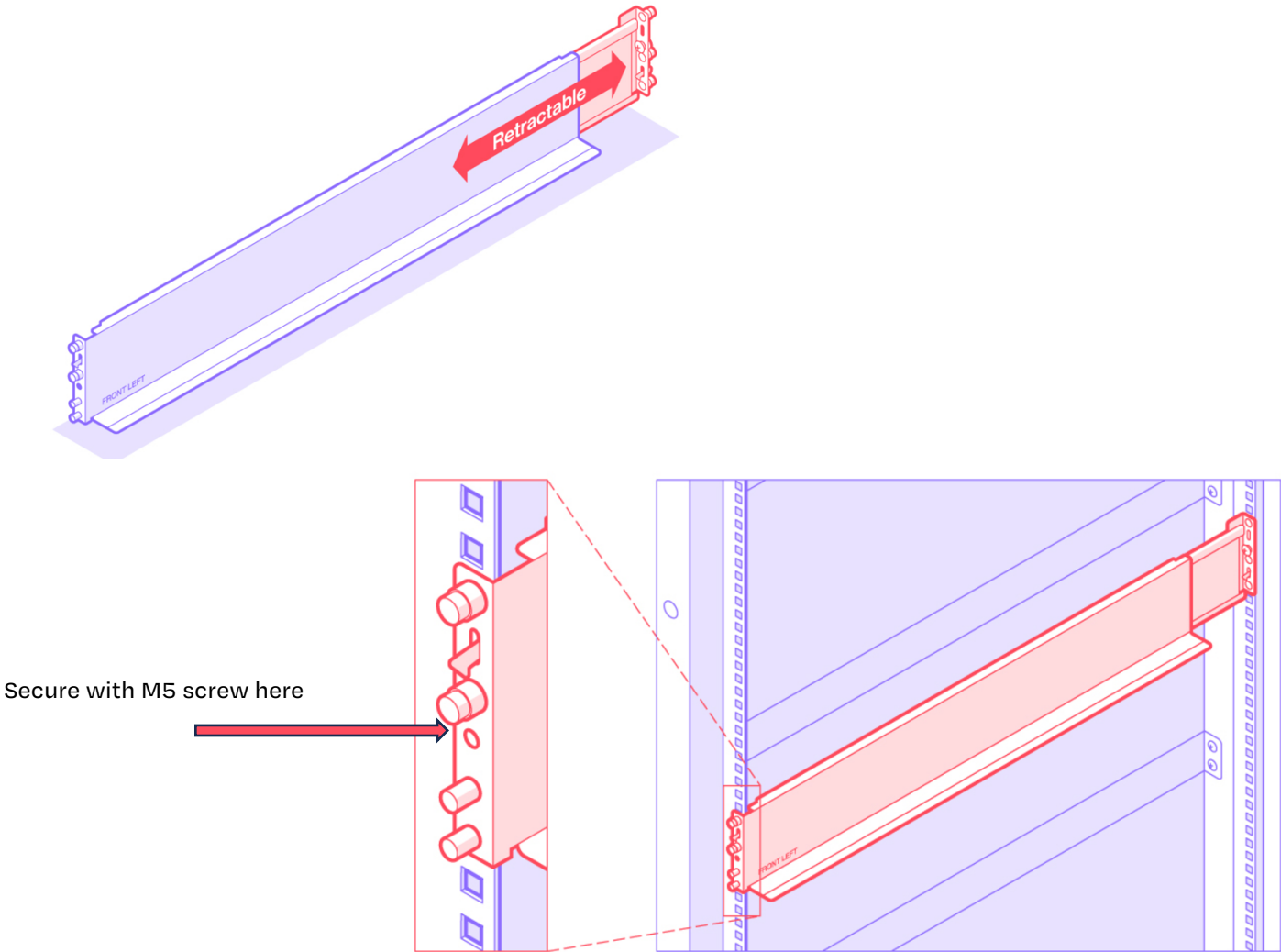

Figure 12
Illustration of Rack Assembly

4.2 Securing the Server to Rack

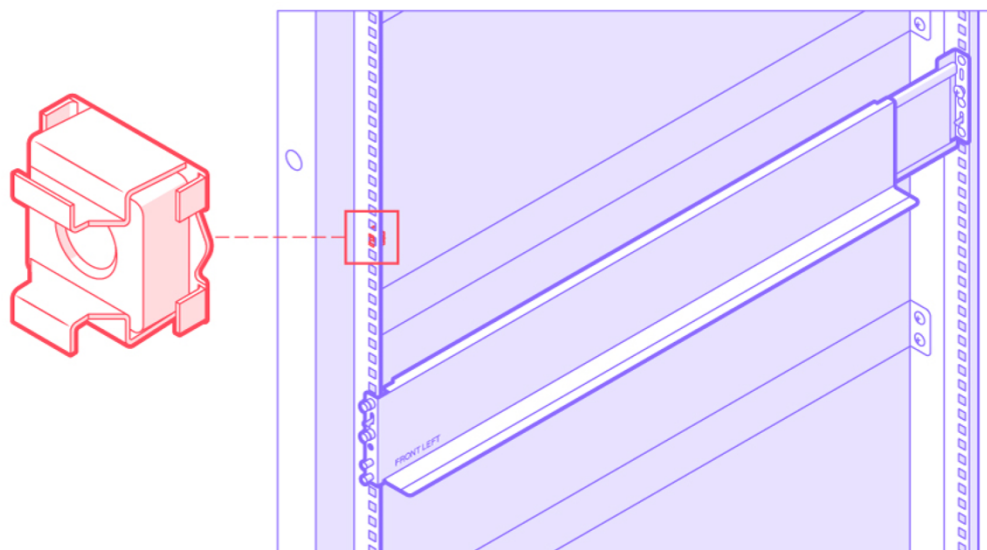

Figure 13
Rack Nut Placement

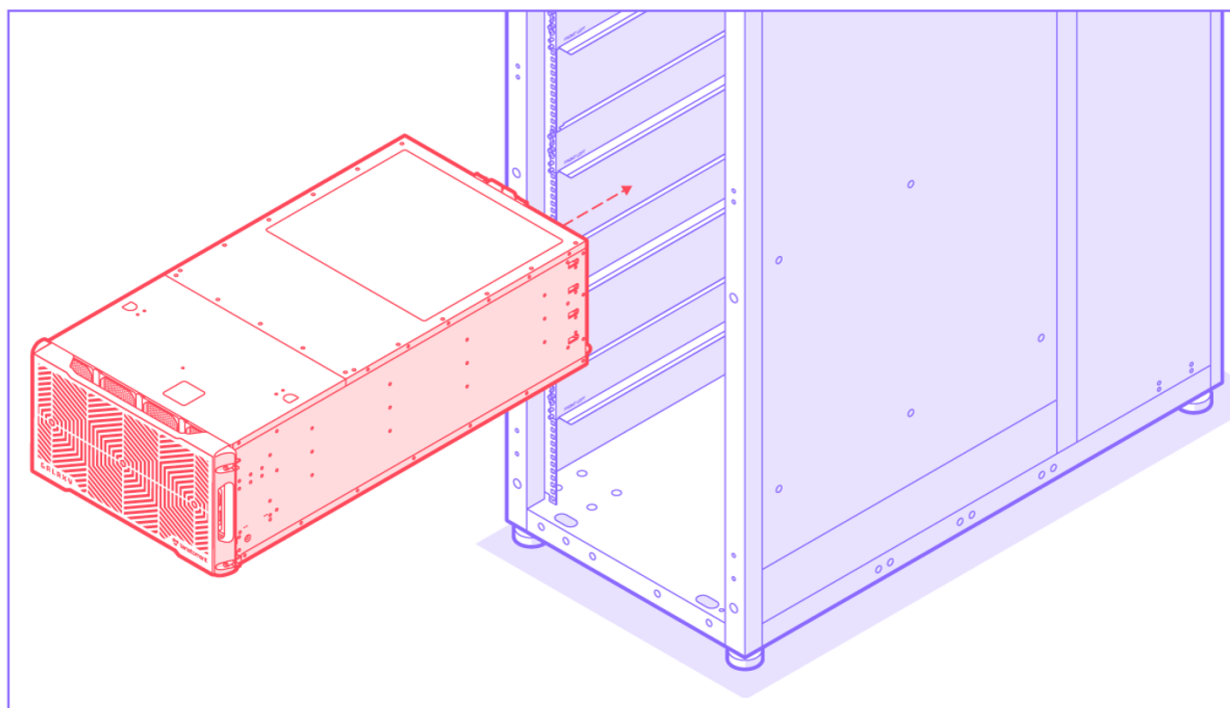

Figure 14
Slide Server into Rack

Caution: Server Weighs 262 lbs. To Avoid Injury or Damage, Use a Server Lift

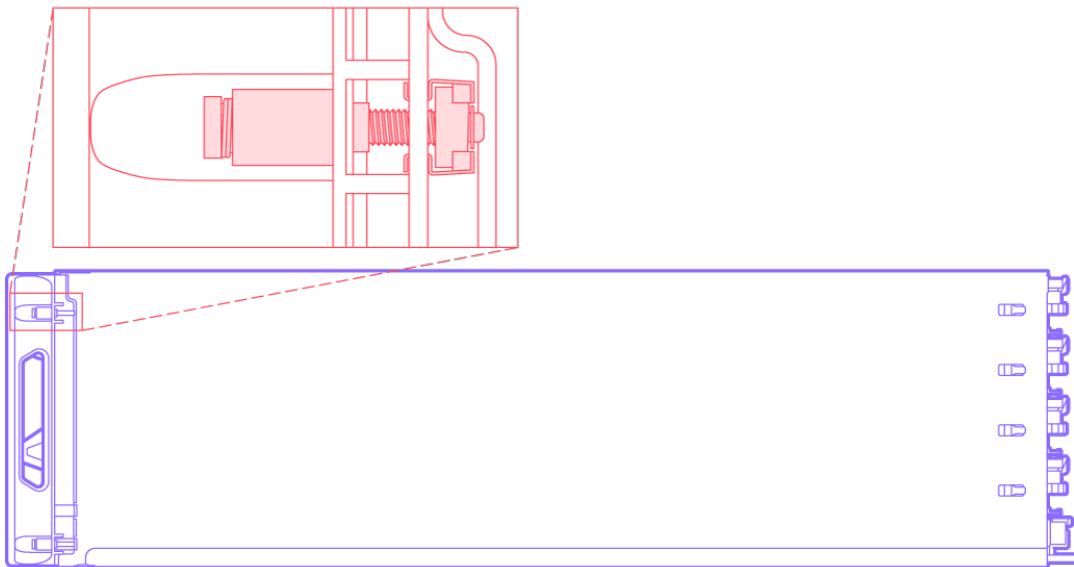

Figure 15
Interior View of Screws Securing Server to Rack

5. Software and Firmware

5.1 Software

For full software setup instructions, please visit

https://github.com/tenstorrent/tt-metal/blob/main/docs/source/tech_reports/WH_Galaxy/Galaxy_WH_6U_SW_Guide.md

Tenstorrent provides a bash script, [tt-installer](#), for fast and easy setup of the Tenstorrent software stack. The installer supports Ubuntu, Fedora, and Debian.

The TT-Metalium (<https://github.com/tenstorrent/tt-metal>) repository landing page on GitHub indicates models that can be run on Tenstorrent Galaxy systems and is frequently updated.

5.2 Firmware

For current firmware information, please visit:

<https://github.com/tenstorrent/tt-metal/blob/main/INSTALLING.md#2-install-driver--firmware>

Below shows the Server's major firmware sources and their functions:

- BIOS: AMI
- BMC: OpenBMC
- Tray FPGA:
 - TTP power-on sequence.
 - TTP GPIO control.
 - TTP JTAG MUX.
 - Buffering of TTP telemetry information.
 - Buffering of TTP voltage sensors.
 - Buffering of BCM87326 & BCM85361 temperature sensors.
 - Buffering of QSFP-DD temperature sensors.
 - QSFP-DD GPIO & reset sequence.
 - BCM87326 & BCM85361 MDIO MUX.
 - BCM87326 & BCM85361 parallel FLASH program.
- PDB FPGA:
 - PSU redundancy mechanism.
 - PSU over current warning detection.
 - FAN PWM controller and tach sensors.
 - SSD reset sequence.
 - SSD LED control.
- TTP JTAG MUX
- MB FPGA:
 - CPU power-on sequence.
 - BMC GPIO extension.
 - CPU/TTP JTAG MUX

5.3 Driver, Firmware, and Software Installation

The following table indicates driver and firmware versions for the Server:

OS	Python	Driver (TT-KMD)	Firmware (TT-Flash)	TT-SMI
Ubuntu 22.04	3.10	v1.33 or above	fw_pack-80.17.0.0 (v80.17.0.0)	v3.0.15 or above

Install System-level Dependencies

To install system-level dependencies run the following command: 

```
wget https://raw.githubusercontent.com/tenstorrent/tt-metal/refs/heads/main/{install_dependencies.sh,tt_metal/sfpi-version.sh}
chmod a+x install_dependencies.sh
sudo ./install_dependencies.sh
```

Install the Driver (TT-KMD)

To install DKMS on Ubuntu run the following command

```
apt install dkms
```

To install the latest TT-KMD version run the following command

```
git clone https://github.com/tenstorrent/tt-kmd.git
cd tt-kmd
sudo dkms add .
sudo dkms install "tenstorrent/${./tools/current-version}"
sudo modprobe tenstorrent
cd ..
```

For more information regarding TT-KMD see the [TT-KMD GitHub repository](#).

Update Device TT-Firmware with TT-Flash

To install TT-Flash run the following command:

```
pip install git+https://github.com/tenstorrent/tt-flash.git
```

tt-flash --version should return tt-flash version if installed properly

To update TT-Firmware, first set the TT-Firmware to the following version

```
fw_tag=v80.17.0.0 fw_pack=fw_pack-80.17.0.0.fwbundle
```

To download and install TT-Firmware run the following command

```
wget https://github.com/tenstorrent/tt-
firmware/raw/refs/tags/$fw_tag/$fw_pack
tt-flash flash --fw-tar $fw_pack
```

Expected Output:

```
Sub Stage FLASH Step 2: Wormhole[23] {Galaxy Wormhole}
  Writing new firmware... SUCCESS
  Firmware verification... SUCCESS
Sub Stage FLASH Step 2: Wormhole[24] {Galaxy Wormhole}
  Writing new firmware... SUCCESS
  Firmware verification... SUCCESS
Sub Stage FLASH Step 2: Wormhole[25] {Galaxy Wormhole}
  Writing new firmware... SUCCESS
  Firmware verification... SUCCESS
Sub Stage FLASH Step 2: Wormhole[26] {Galaxy Wormhole}
  Writing new firmware... SUCCESS
  Firmware verification... SUCCESS
Sub Stage FLASH Step 2: Wormhole[27] {Galaxy Wormhole}
  Writing new firmware... SUCCESS
  Firmware verification... SUCCESS
Sub Stage FLASH Step 2: Wormhole[28] {Galaxy Wormhole}
  Writing new firmware... SUCCESS
  Firmware verification... SUCCESS
Sub Stage FLASH Step 2: Wormhole[29] {Galaxy Wormhole}
  Writing new firmware... SUCCESS
  Firmware verification... SUCCESS
Sub Stage FLASH Step 2: Wormhole[30] {Galaxy Wormhole}
  Writing new firmware... SUCCESS
  Firmware verification... SUCCESS
Sub Stage FLASH Step 2: Wormhole[31] {Galaxy Wormhole}
  Writing new firmware... SUCCESS
  Firmware verification... SUCCESS
FLASH SUCCESS
```

For more information regarding TT-Firmware and TT-Flash see their respective GitHub repositories: [TT-Firmware](#) and [TT-Flash](#).

Install System Management Interface (TT-SMI)

To install the System Management Interface run the following command: ✓

```
pip install git+https://github.com/tenstorrent/tt-smi@v3.0.15
```

Once hardware and system software are installed verify that the system has been configured correctly by running the following TT-SMI utility: ✓

```
tt-smi
```

TT-SMI will run without error if your system has been configured correctly. The following display with device information, telemetry, and firmware will appear:

```

Version 3.0.15                                     TT-SMI                                     Jun 11 2025 03:08:35 PM
Host Info (Fully Compatible)
* OS       : Linux (x86_64)
* Distro   : Ubuntu 22.04.5 LTS
* Kernel   : 5.15.0-141-generic
* Hostname : g05g1x01
* Python   : 3.10.12
* Memory   : 566.12 GB
* Driver   : TT-KMD 1.33

Information (1) Telemetry (2) FW Version (3)

Device Information
#      Bus ID      Board Type      Board ID      Coords      DRAM Trained  DRAM Speed  Link Speed  Link Width
0      0000:c3:00.0  N/A            10003510000000 (0, 0, 0, 0) Y            14G         Gen4 / Gen4 x1 / x16
1      0000:c2:00.0  N/A            10003510000000 (0, 0, 0, 0) Y            14G         Gen4 / Gen4 x1 / x16
2      0000:c1:00.0  N/A            10003510000000 (0, 0, 0, 0) Y            14G         Gen4 / Gen4 x1 / x16
3      0000:c7:00.0  N/A            10003510000000 (0, 0, 0, 0) Y            14G         Gen4 / Gen4 x1 / x16
4      0000:c5:00.0  N/A            10003510000000 (0, 0, 0, 0) Y            14G         Gen4 / Gen4 x1 / x16
5      0000:c8:00.0  N/A            10003510000000 (0, 0, 0, 0) Y            14G         Gen4 / Gen4 x1 / x16
6      0000:c4:00.0  N/A            10003510000000 (0, 0, 0, 0) Y            14G         Gen4 / Gen4 x1 / x16
7      0000:c6:00.0  N/A            10003510000000 (0, 0, 0, 0) Y            14G         Gen4 / Gen4 x8 / x16
8      0000:82:00.0  N/A            10003510000000 (0, 0, 0, 0) Y            14G         Gen4 / Gen4 x1 / x16
9      0000:88:00.0  N/A            10003510000000 (0, 0, 0, 0) Y            14G         Gen4 / Gen4 x1 / x16
10     0000:87:00.0  N/A            10003510000000 (0, 0, 0, 0) Y            14G         Gen4 / Gen4 x1 / x16
11     0000:85:00.0  N/A            10003510000000 (0, 0, 0, 0) Y            14G         Gen4 / Gen4 x1 / x16
12     0000:84:00.0  N/A            10003510000000 (0, 0, 0, 0) Y            14G         Gen4 / Gen4 x1 / x16
13     0000:81:00.0  N/A            10003510000000 (0, 0, 0, 0) Y            14G         Gen4 / Gen4 x1 / x16
14     0000:83:00.0  N/A            10003510000000 (0, 0, 0, 0) Y            14G         Gen4 / Gen4 x1 / x16
15     0000:86:00.0  N/A            10003510000000 (0, 0, 0, 0) Y            14G         Gen4 / Gen4 x8 / x16
16     0000:07:00.0  N/A            10003510000000 (0, 0, 0, 0) Y            14G         Gen4 / Gen4 x1 / x16
17     0000:01:00.0  N/A            10003510000000 (0, 0, 0, 0) Y            14G         Gen4 / Gen4 x1 / x16
18     0000:03:00.0  N/A            10003510000000 (0, 0, 0, 0) Y            14G         Gen4 / Gen4 x1 / x16
19     0000:02:00.0  N/A            10003510000000 (0, 0, 0, 0) Y            14G         Gen4 / Gen4 x1 / x16
20     0000:04:00.0  N/A            10003510000000 (0, 0, 0, 0) Y            14G         Gen4 / Gen4 x1 / x16
21     0000:05:00.0  N/A            10003510000000 (0, 0, 0, 0) Y            14G         Gen4 / Gen4 x1 / x16
22     0000:08:00.0  N/A            10003510000000 (0, 0, 0, 0) Y            14G         Gen4 / Gen4 x1 / x16
23     0000:06:00.0  N/A            10003510000000 (0, 0, 0, 0) Y            14G         Gen4 / Gen4 x8 / x16
24     0000:45:00.0  N/A            10003510000000 (0, 0, 0, 0) Y            14G         Gen4 / Gen4 x1 / x16
25     0000:43:00.0  N/A            10003510000000 (0, 0, 0, 0) Y            14G         Gen4 / Gen4 x1 / x16
26     0000:47:00.0  N/A            10003510000000 (0, 0, 0, 0) Y            14G         Gen4 / Gen4 x1 / x16
27     0000:42:00.0  N/A            10003510000000 (0, 0, 0, 0) Y            14G         Gen4 / Gen4 x1 / x16
28     0000:44:00.0  N/A            10003510000000 (0, 0, 0, 0) Y            14G         Gen4 / Gen4 x1 / x16
29     0000:48:00.0  N/A            10003510000000 (0, 0, 0, 0) Y            14G         Gen4 / Gen4 x1 / x16
30     0000:41:00.0  N/A            10003510000000 (0, 0, 0, 0) Y            14G         Gen4 / Gen4 x1 / x16
31     0000:46:00.0  N/A            10003510000000 (0, 0, 0, 0) Y            14G         Gen4 / Gen4 x8 / x16

0 Quit H Help D Toggle dark mode C Toggle sidebar 1 Device info tab 2 Telemetry tab 3 Firmware tab

```

Install Metalium

1. Clone the Repository - Run the following command to clone the repository

```
git clone https://github.com/tenstorrent/tt-metal.git --recurse-submodules
```

2. Invoke Metalium build scripts - Run the following command to invoke Metalium build scripts:

```
./build_metal.sh
```

3. We recommend for an out-of-the-box virtual environment, that you run the following command:

```
./create_venv.sh  
source python_env/bin/activate
```

4. Environment Variables - To set environment variables run the following command:

```
export TT_METAL_HOME=$(pwd)  
export PYTHONPATH=$(pwd)
```

5.4 Troubleshooting

If you suspect system issues in Galaxy Wormhole 6U systems reference the following troubleshooting methods to diagnose and correct any problems. The [TT-Metal](#) repository landing page on GitHub lists models that can be run on 6U systems. Look for models that indicate that Galaxy hardware is used.

Checking the system status through `tt - smi` command will show system information, firmware version, and telemetry data.

```
>> tt - smi
```

To get initial system data, run the below commands. If needed, file a ticket with the Tenstorrent support team with this data, along with the description of the problem.

Items	Commands
Read FRU	<code>sudo ipmitool fru print</code>
Get BMC version	<code>sudo ipmitool mc info</code>
Get BIOS version	<code>sudo dmidecode -t0</code>
Get MB CPLD version	<code>sudo ipmitool raw 0x06 0x52 0x17 0x62 0x04 0x00</code>
Get PDB CPLD version	<code>sudo ipmitool raw 0x06 0x52 0x09 0x62 0x04 0x00</code>
Get UBB CPLD version	UBB1: <code>sudo ipmitool raw 0x06 0x52 0x0D 0x80 0x04 0x00</code> UBB2: <code>sudo ipmitool raw 0x06 0x52 0x0F 0x80 0x04 0x00</code> UBB3: <code>sudo ipmitool raw 0x06 0x52 0x11 0x80 0x04 0x00</code> UBB4: <code>sudo ipmitool raw 0x06 0x52 0x13 0x80 0x04 0x00</code>
Get Retimer/Redriver version	<code>curl -k -u root:0penBmc</code> https://{bmc_ipAddress?}/redfish/v1/UpdateService/DevFirmware/retimer0 <code>curl -k -u root:0penBmc</code> https://{bmc_ipAddress?}/redfish/v1/UpdateService/DevFirmware/retimer1 <code>curl -k -u root:OpenBmc</code> https://{bmc_ipAddress?}/redfish/v1/UpdateService/DevFirmware/retimer2 <code>curl -k -u root:OpenBmc</code> https://{bmc_ipAddress?}/redfish/v1/UpdateService/DevFirmware/retimer3 <code>curl -k -u root:OpenBmc</code> https://{bmc_ipAddress?}/redfish/v1/UpdateService/DevFirmware/retimer4 <code>curl -k -u root:OpenBmc</code> https://{bmc_ipAddress?}/redfish/v1/UpdateService/DevFirmware/retimer5 <code>curl -k -u root:OpenBmc</code> https://{bmc_ipAddress?}/redfish/v1/UpdateService/DevFirmware/pdbredriver

Dump the system event logs:

Items	Commands
Dump SDR	sudo ipmitool sdr list
Dump SEL	sudo ipmitool sel elist

6. Server Reset

This information is subject to change. **See [GitHub link](#) in section 5.3 for the latest information.**

There are two options available for resetting the Server trays:

- `glx_reset`: resets the galaxy, informs users if there has been an eth failure
- `glx_reset_auto`: resets the galaxy upto 3 times if eth failures are detected
- `glx_reset_tray <tray_num>`: performs reset on one galaxy tray. Tray number must be between 1-4

Full Server reset:

```
tt-smi -glx_reset
Resetting WH Galaxy trays with reset command...
Executing command: sudo ipmitool raw 0x30 0x8B 0xF 0xFF 0x0 0xF
Waiting for 30 seconds: 30
Driver loaded
Re-initializing boards after reset....
Detected Chips: 32
Re-initialized 32 boards after reset. Exiting...
```

Tray reset:

```
tt-smi -glx_reset_tray 3 --no_reinit
Resetting WH Galaxy trays with reset command...
Executing command: sudo ipmitool raw 0x30 0x8B 0x4 0xFF 0x0 0xF
Waiting for 30 seconds: 30
Driver loaded
Re-initializing boards after reset....
Exiting after galaxy reset without re-initializing chips.
```

7. Server Shutdown

At this time, hot-swapping is not recommended for any components, except for the specified hot-plug fan, PSUs and E1.S drives. Tenstorrent will announce when hot-swapping functionality becomes available for other parts.



Caution: Shock hazard. This Server has multiple power sources.

Disconnect all power sources before servicing.

Before servicing or part replacement, the Server must be shut down, have all power supplies disconnected, and allowed to cool.



Warning: Hot Surfaces.

The external surfaces of the Server may reach high temperatures during normal operation and will retain heat for a significant period after disconnecting power. Only proceed with servicing after surfaces have cooled.

The Server can be shut down **Orderly** or **Immediately**.

An **Immediate** shut down from the BMC will cut off power to the head node without waiting for the OS to shutdown first. (In some cases, this can lead to file corruption. To avoid this, perform an **Orderly** shutdown whenever possible.)

- Login to the BMC.
- Navigate to the Power menu.
- Trigger "Power Off".
- Once the Server shuts down, unplug power cables.
- Wait a few minutes to allow each of the PSUs to fully drain.

Alternatively, running the command `shutdown -h now` from the terminal will perform an **Orderly** shutdown. You can schedule an orderly shutdown by specifying a time other than `now`.

The images on the following page show how to navigate to the Power shutdown section of the BMC.

1. Login to the BMC.

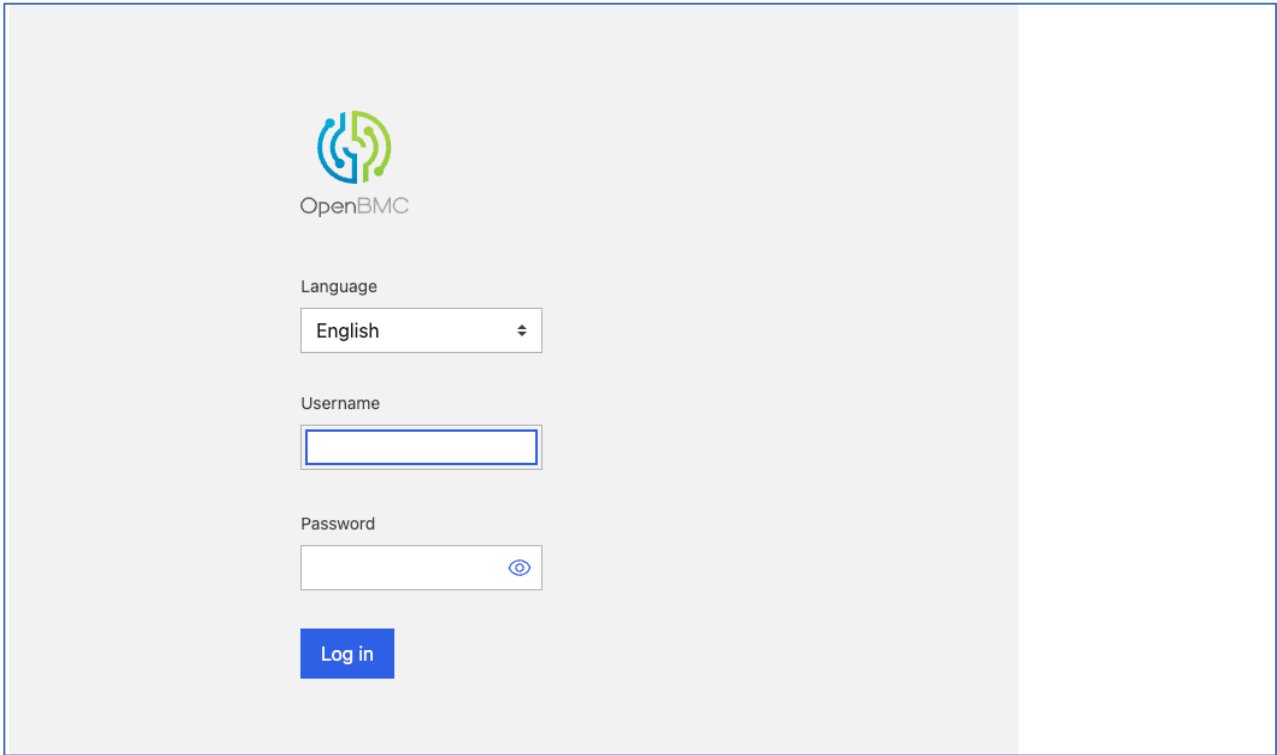
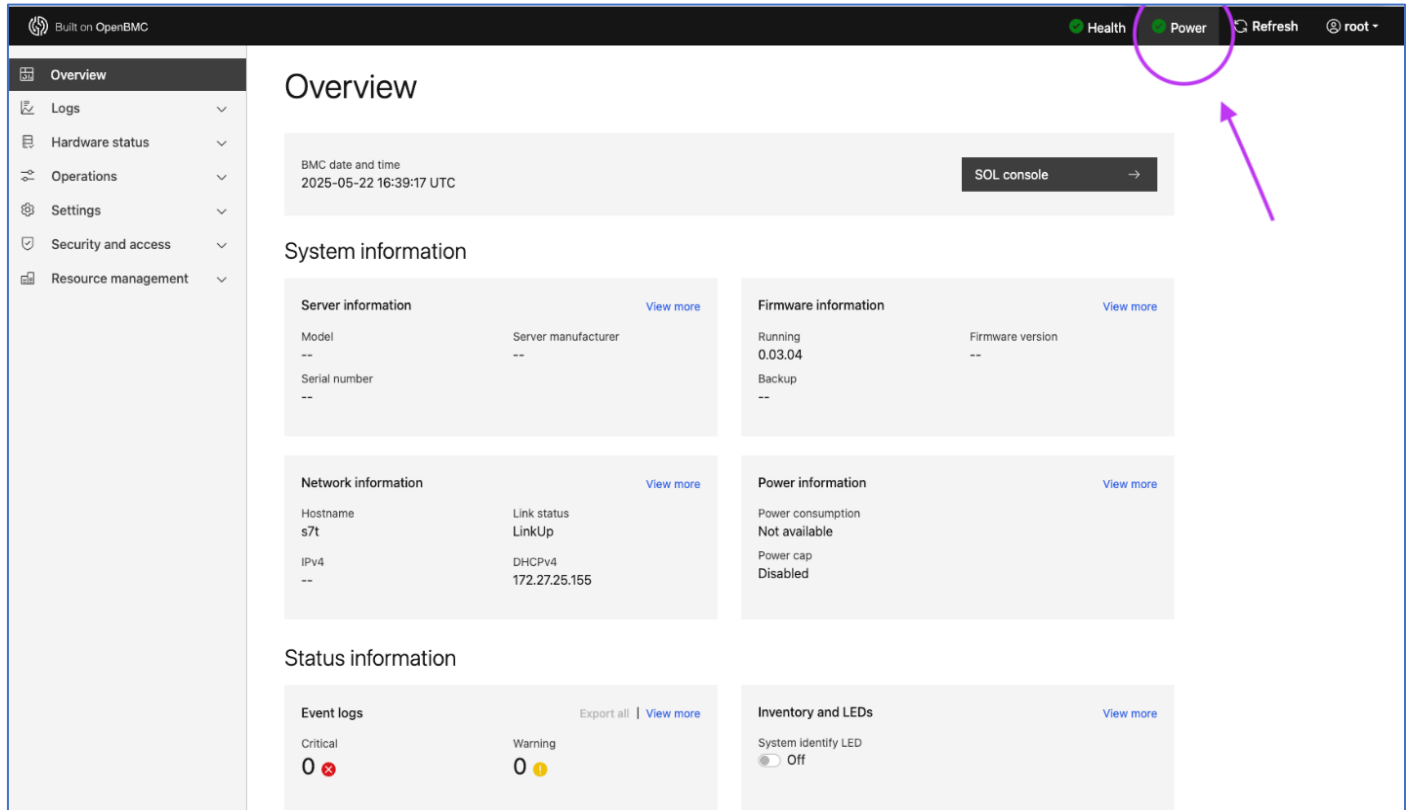

Figure 16
BMC Login Screen Screenshot

2. Navigate to the Power section of the BMC.



The screenshot shows the BMC Overview page. The top navigation bar includes 'Health', 'Power', 'Refresh', and 'root'. The 'Power' tab is highlighted with a purple circle and a purple arrow. The main content area is divided into several sections:

- Overview:** BMC date and time: 2025-05-22 16:39:17 UTC. SOL console button.
- System information:**
 - Server information:** Model, Server manufacturer, Serial number. View more link.
 - Firmware information:** Running: 0.03.04, Backup, Firmware version. View more link.
 - Network information:** Hostname: s7t, Link status: LinkUp, IPv4, DHCPv4: 172.27.25.155. View more link.
 - Power information:** Power consumption: Not available, Power cap: Disabled. View more link.
- Status information:**
 - Event logs:** Critical: 0 (red X), Warning: 0 (yellow dot). Export all | View more link.
 - Inventory and LEDs:** System identify LED: Off. View more link.

Figure 17

Screenshot of BMC Overview with Power Section Highlighted

3. Select Preferred Shutdown Sequence.

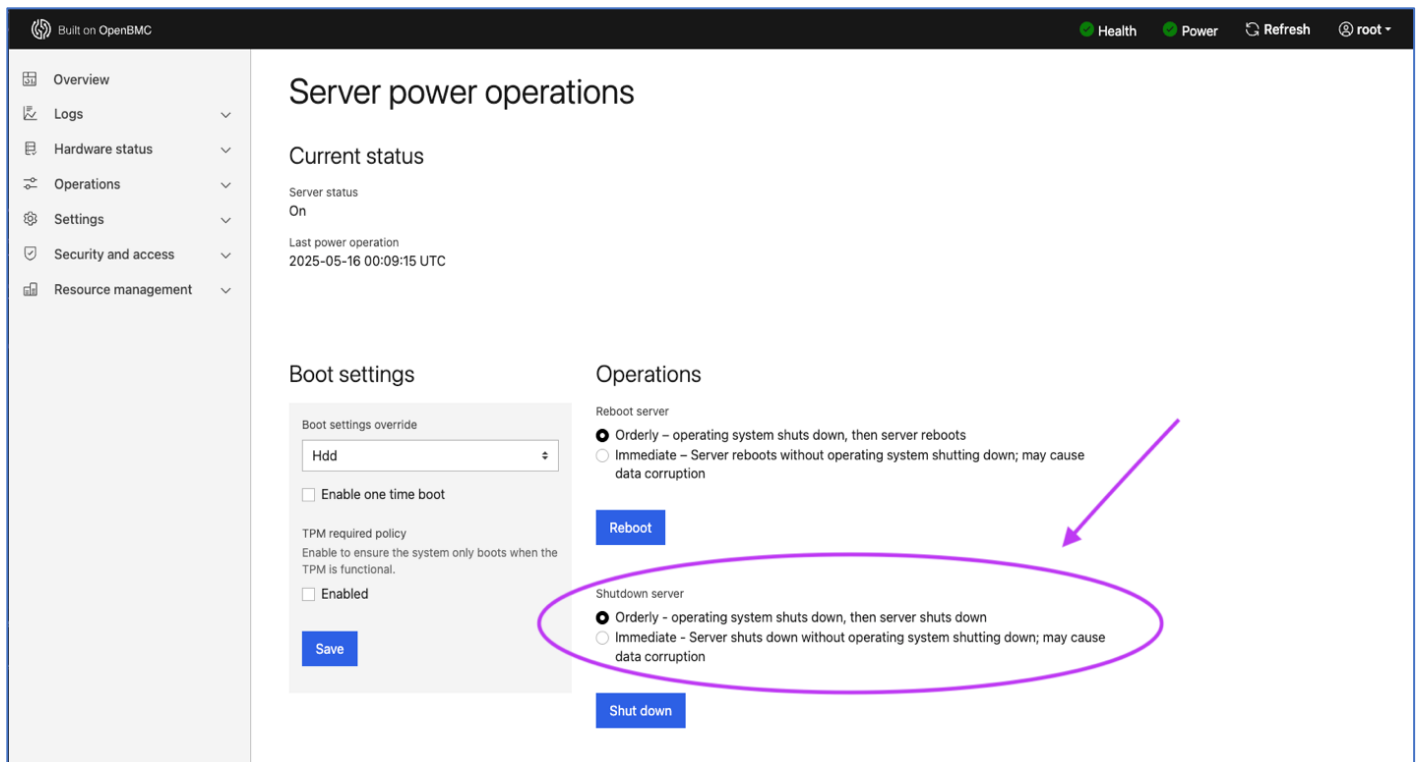

Figure 18
Screenshot of Orderly Shutdown Option in BMC

4. Once the power is off, unplug the power cables and wait a few minutes for the PSUs to drain before beginning any hardware servicing.

8. Compliance

An updated list of EMC, Safety and Regulatory notices for the Tenstorrent Galaxy Wormhole Server will be available at www.docs.tenstorrent.com, or by contacting Tenstorrent at regulatory@tenstorrent.com

Manufacturer

Tenstorrent, Inc
2600 Great America Way
Suite 501
Santa Clara, CA 95054
USA

Japan VCCI Statement

この装置は、クラスA機器です。この装置を住宅環境で使用すると電波妨害を引き起こすことがあります。この場合には使用者が適切な対策を講ずるよう要求されることがあります。

VCCI - A

BSMI Taiwan Compliance Statement

警告：為避免電磁干擾，本產品不應安裝或用於住宅環境。

WARNING: This is a Class A Information Technology Product. To avoid electromagnetic interference, this product should not be installed or used in a residential environment.

